

METAL[®]
WHOLESALE LLC

Metal Roofing
FAST!



Request Metal Wholesale at your local lumberyard!

Contents

A - Panels

PRIME 3/4" Rib
Drip Stop
Trim (Standard)
Snaplock
Snaplock - Trim
Speedlap
Metal Batten
Metal Batten - Trim
PBR
PBR - Trim

B - Accessories

Fasteners (Screws, Nails and Rivets)
Pipe Flashing
Skylights
Corrugated Panel
Ridge Vent
Cupolas
Weathervanes
Snow Guard
Bending Bar/Hemmer Tool
Touch Up Pens
Sealants
Closures and Vented Products

C - Information

Layers of Protection
Understanding Our Substrates
TEXTURED Metal Wins Again
TEXTURED Metal Advantages
Roof Metal Length Calculation
How To Figure Screw Quantity
Square Conversions
Trims Placement Chart
Color Availability Chart

AL	Alamo White
AG	Ash Gray
BA	Bare Galvalume
BW	Brilliant White
BR	Brite Red
BN	Brown
BU	Buckskin
BG	Burgundy
BS	Burnished Slate
CH	Charcoal
CM	Copper Metallic
DG	Dark Green
GB	Gallery Blue
HU	Hunter Green
IV	Ivory
LS	Light Stone
MB	Matte Black
OC	Ocean
PG	Pewter Gray
RU	Rustic Red
TN	Tan
TA	Taupe
WO	Warm Oak
WG	Weathered Gray
TAG	Textured Ash Gray
TBW	Textured Brilliant White
TBN	Textured Brown
TBG	Textured Burgundy
TBS	Textured Burnished Slate
TCH	Textured Charcoal
TDG	Textured Dark Green
TGB	Textured Gallery Blue
TGR	Textured Graphite
TMB	Textured Matte Black
TRU	Textured Rustic Red
TTA	Textured Taupe

Ask for Metal Wholesale at your local lumberyard!

PRIME 3/4" Rib

Panels

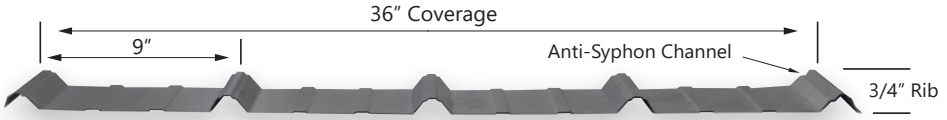

29 Gauge is available in all colors!

26 Gauge is available in 18 colors!

(2 week lead time)

(See Color Availability page for available selection)

PRIME 3/4" Rib

TEXTURED

P9T Textured 29 Gauge

Smooth

P9 Smooth 29 Gauge

P6 Smooth 26 Gauge

P9ALGI Smooth 29 Gauge ALAMO G100

P8BWGI Smooth 28 Gauge BRILLIANT WHITE G100

For panel lengths over 46' additional delivery charges may apply

Liner

Smooth

29 Gauge
26 Gauge

P9LI LINER 29 Gauge BRILLIANT WHITE

Up to 4' on center spacing

P6LI LINER 26 Gauge BRILLIANT WHITE

Up to 8' on center spacing

Perforated



P9PEBW PERFORATED 29 Gauge BRILLIANT WHITE

- Sound deadening acoustic panel
- Recommended for interior ceilings
- Up to 4' on center spacing

Condensation Control

Drip Stop

****DS

Drip Stop can be applied to all
3/4" Rib Panels

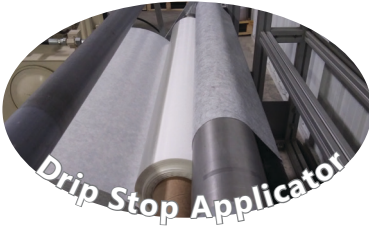

Areas of use:

- Post frame/agricultural buildings
- Self-storage buildings
- Workshops and garages
- Insulated buildings with ceilings

*Drip Stop can hold more than
one quart of water per ten
square feet of space!*

Advantages:

- Cuts installation time nearly in half with no labor needed for installing insulation.
- Allows you to work on the roof when the weather normally would keep you off.
- Arrives at the jobsite on the steel - saving you time.
- Protects the steel, by reducing contact with corrosive fumes.



How it works

When climate conditions cause condensation to occur, Drip Stop absorbs and holds that moisture in specially designed pockets in the membrane. When conditions return to above dew point, the moisture is released back into the air as normal humidity.



Caution!

We recommend using a bottle torch to carefully burn the Drip Stop off the bottom edge of the panel on the eaves side to prevent wicking from the outside weather.

Trim

Panels

All trims are available in 10'6", 12'6", 14'6", 16'6", 18'6" and 20'6"

Corner

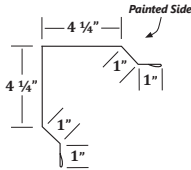

C 6" Corner

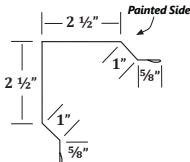

C4 4" Corner

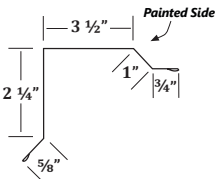

RR Residential Rake

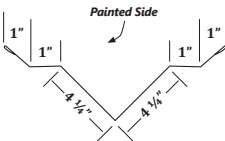

IC 6" INSIDE Corner

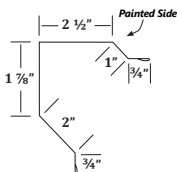

YL54 #54 Corner with 1-1/2" offset

Ridge

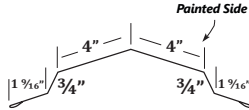

RC 12" Ridge Cap

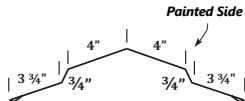

RC16 16" Ridge Cap

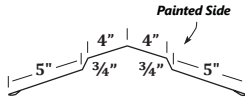

RC19 19" Ridge Cap

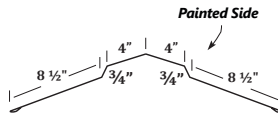

RC26 26" Ridge Cap

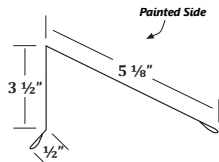

HS High Side Trim

Valley

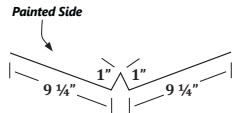

VA20 20" Valley

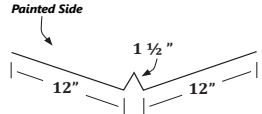

VA24 24" Valley

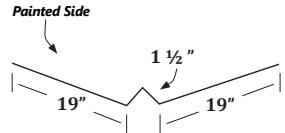

VA40 40" Valley



Special trims are made with ease at Metal Wholesale. Please provide a drawing when ordering custom trim.

Panels

Trim

All trims are available in 10'6", 12'6", 14'6", 16'6", 18'6" and 20'6"

Eave

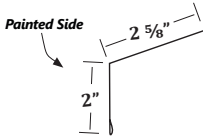

GA Gutter Apron

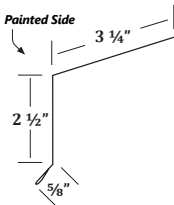

RE Residential Eave

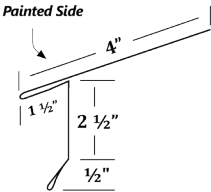

RDE Residential Drip Edge

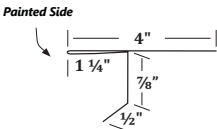

DE114 1-1/4 Drip Edge

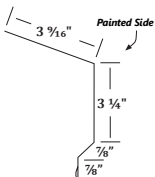

EF 5 Eave Facsia

Transition

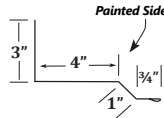

SW Sidewall

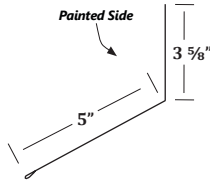

EW Endwall

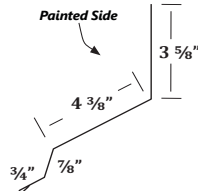

EWO Endwall with Offset

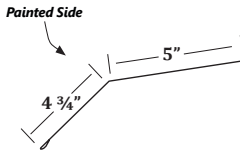

UG Upper Gambrel

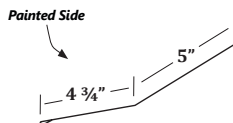

LG Lower Gambrel

Base

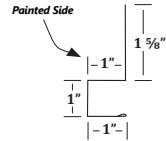

SB Square Base

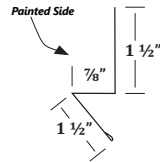

RG Rat Guard

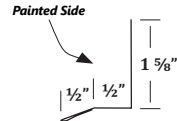

BA Base Angle

Sliding Door

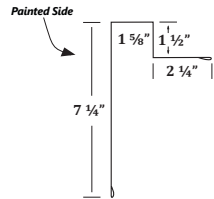

SDJ Sliding Door Jamb

Trim

Panels

All trims are available in 10'6", 12'6", 14'6", 16'6", 18'6" and 20'6"

Wainscot

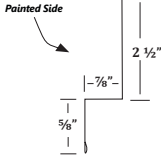

DA5 5/8" Double Angle

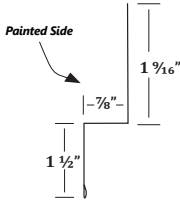

DA 1-1/2" Double Angle

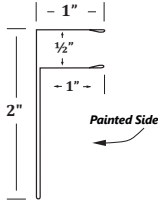

F 1/2" F-Channel

Soffit

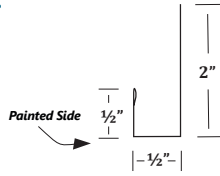

SJ Soffit J-Channel

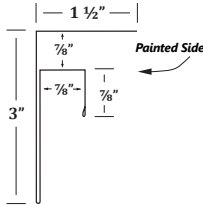

FJ7 7/8" F&J

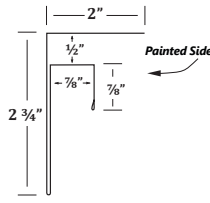

FJ 1/2" F&J

Window

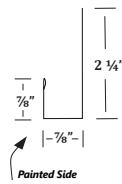

J J-Channel

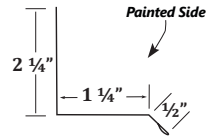

WD Window Drip Cap

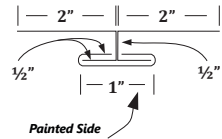

SD 3 Piece Soffit Divider

Painted Inside!

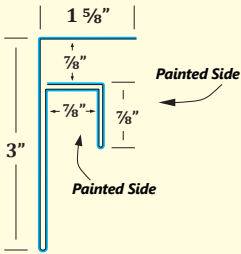

FJ7PI 7/8" F&J Painted Inside

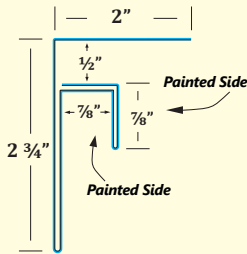

FJPI 1/2" F&J Painted Inside

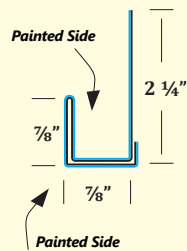

JPI J-Channel Painted Inside

Panels

Trim

All trims are available in 10'6", 12'6", 14'6", 16'6", 18'6" and 20'6"

Outside Angle

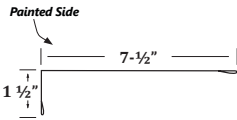

OA712 7-1/2" Outside Angle

OA6 6" Outside Angle

OA512 5-1/2" Outside Angle

OA312 3-1/2" Outside Angle

OA112 1-1/2" Outside Angle

Overhead Door

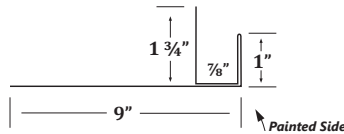

ODJ Overhead Door Jamb

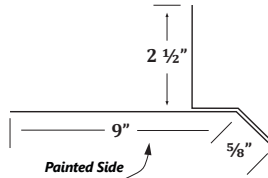

ODD Overhead Door Drip

Versetta Trim

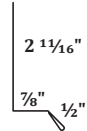

VSC Versetta Stone Cap

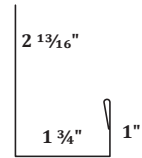

VSJ Versetta Stone J-Channel

INSIDE Angle

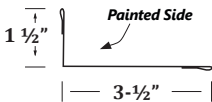

IA312 3-1/2" INSIDE Angle

IA112 1-1/2" INSIDE Angle

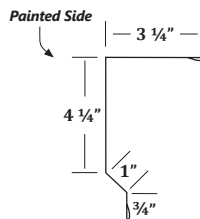

DOE Door Edge

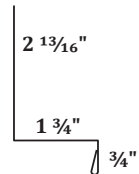

VSDA Versetta Stone Double Angle



We guarantee each piece of trim to be free of defects and bent perfectly.

Trim

Panels

All trims are available in 10'6", 12'6", 14'6", 16'6", 18'6" and 20'6"

Track Cover

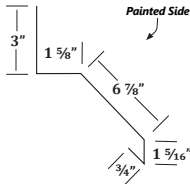

TC Track Cover Round FM

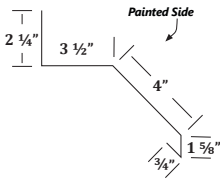

TCTM Track Cover Round TM

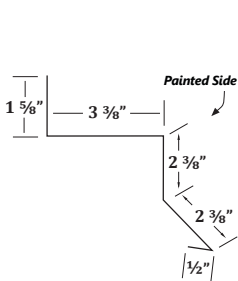

TCSTM Track Cover Square TM

Misc.

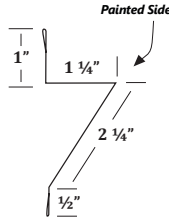

SG Snow Guard

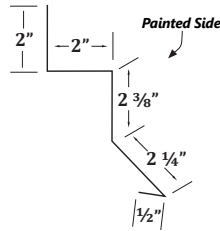

TCS Track Cover Square FM

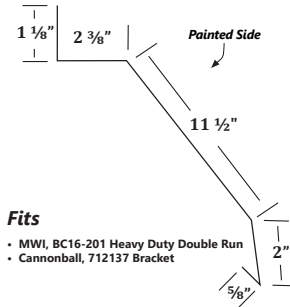

Fits

- MWI, BC16-201 Heavy Duty Double Run
- Cannonball, 712137 Bracket

TCDH Track Cover Double Heavy Duty Round FM

Post Wrap

For a 6" x 6" Post

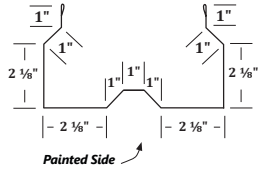

YL240 YL240 Post Wrap

For Laminated
3 Ply 2" x 6" Post
(5 5/16" x 4 5/16")

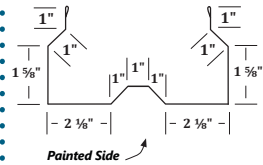

YL550 YL550 Post Wrap

For a 4" x 4" Post

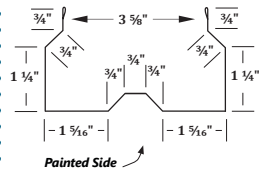

YL615 YL615 Post Wrap

Panels

Snaplock

1"
Rib Height

16" Coverage

Includes foldable tab

Notching is available
for Snap Lock Panel

Snap Lock 26 Gauge

Textured

SL6T*

Smooth

SL6*

Now available in 24 colors!

See Color Availability Chart on page C1 for details

2 Week
lead time



For panel lengths over 46' additional delivery charges may apply

A - 8

All trims are available in 10'6", 12'6", 14'6", 16'6", 18'6" and 20'6"

SL6R SL Rake

Required Trims

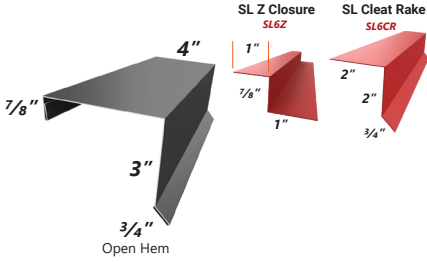

SL6DE SL Drip Edge

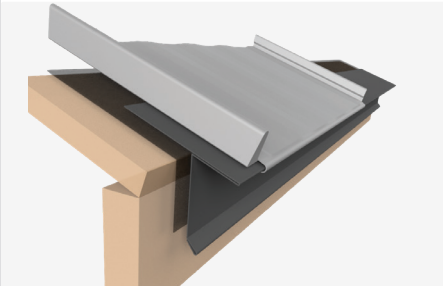
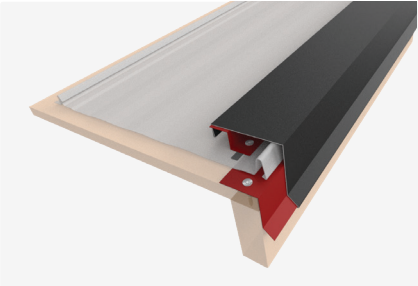
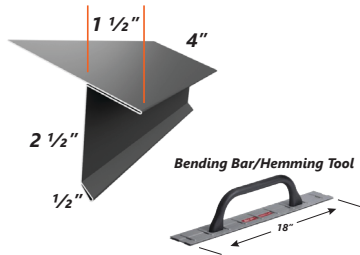

SL6EW SL Endwall

Required Trims
 Z Closure

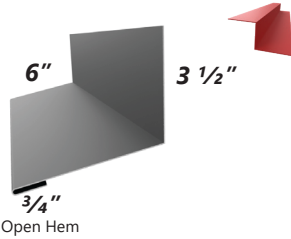

SL6SW SL Sidewall

Required Trims
 Z Closure

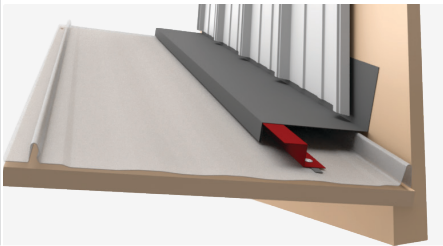
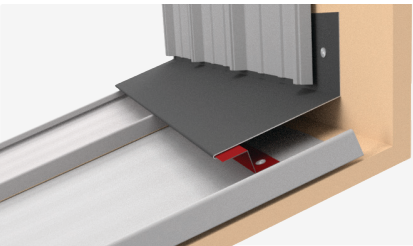
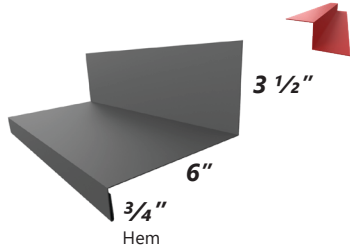

Panels

Snaplock - Trim

All trims are available in 10'6", 12'6", 14'6", 16'6", 18'6" and 20'6"

SL6RC SL 12" Ridge Cap

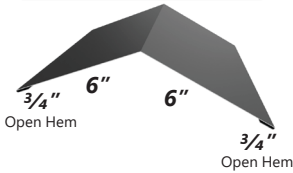

Required Trims

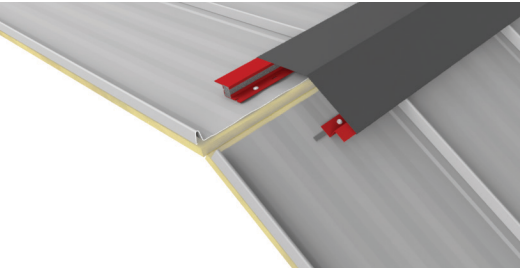
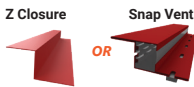

SL6SV Snap Vent

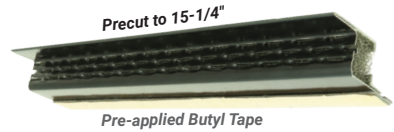

- Net free area of up to 12 sq. in. per linear foot of ridge
- Airflow: 730 cu. ft. per min. (per 10' ridge)

Increased Airflow

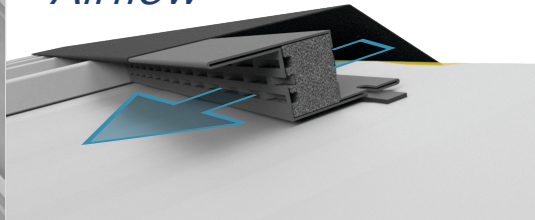

SL6VA SL 20" Valley

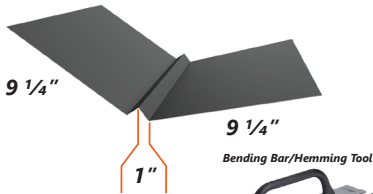

Required Trims

SL6CO SL Cleat Offset

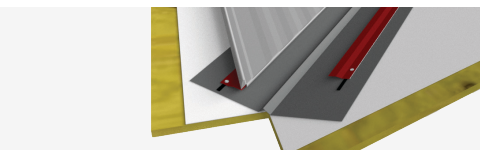
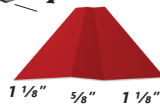

SL6UG SL Upper Gambrel

SL6LG SL Lower Gambrel

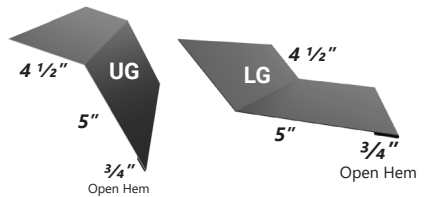

Required Trims

Z Closure SL Cleat Offset



Bending Bar/Hemming Tool

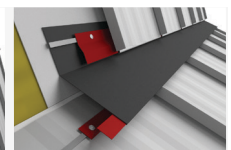
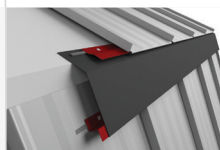



Precut Soffit Panel

Now available in Woodgrain!

Features:

- **Color matched** to our metal roofing and siding
- Available in all colors
- Heavy duty 29 gauge steel
- Fast and easy to install
- Both smooth and textured colors are available
- 15 sq. in. of free area per ft.



Expect 2 week lead time on lengths over 2 feet long

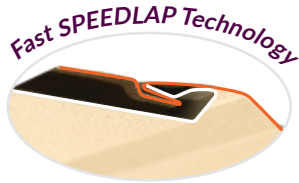

SC** 16" Center Vented Solid Soffit

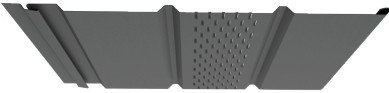

SS** 16" Solid Soffit



SF** 16" Full Vented Soffit

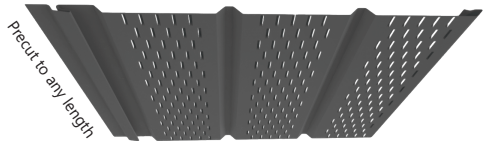

See color availability page for available colors

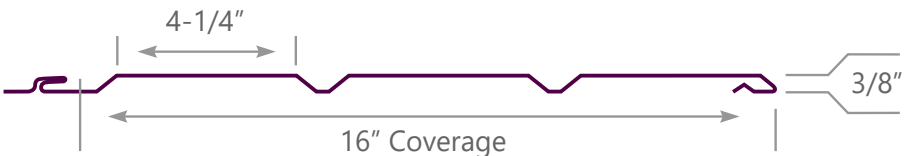

Panels

Metal Batten

TEXTURED

MB9T Textured 29 Gauge

Smooth

MB9 Smooth 29 Gauge



Minimum Length 3'

Max Length 20'

Features:

- **Color matched** to our other panel profiles
- Available in all colors
- Heavy duty 29 gauge steel
- Fast and easy to install
- Both smooth and textured colors are available

2 Week
lead time



A - 12

MBIC MB Inside Corner

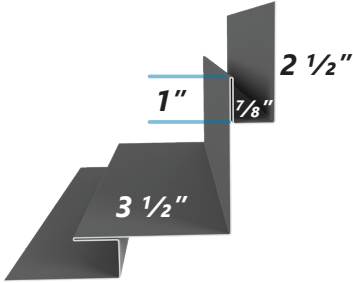

MBC MB Outside Corner

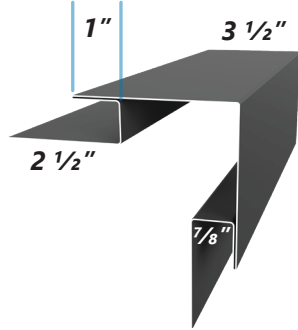

MBBB312 MB 3 1/2" Band Board

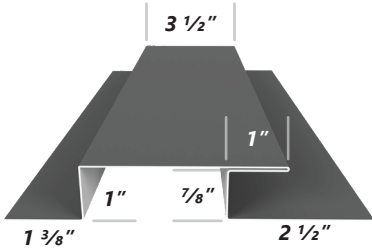

MBBB512 MB 5 1/2" Band Board

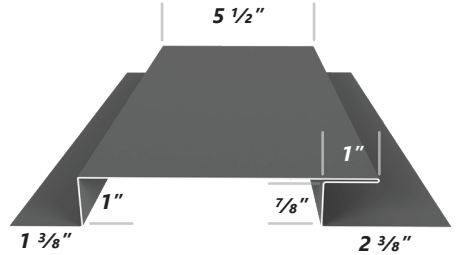

HT Hem Trim

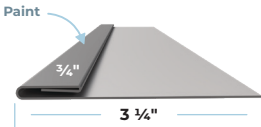

SB Square Base

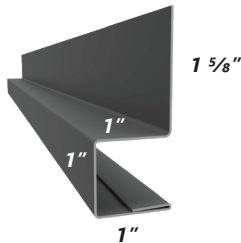

JPI J-Channel (Painted INSIDE)

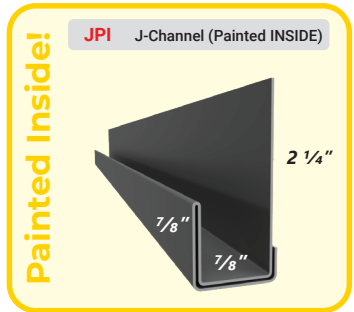



Smooth

PBR6 Smooth 26 Gauge

Features:

- **Color matched** to our other panel profiles
- Heavy duty 26 gauge steel
- Fast and easy to install
- Available in 18 Smooth colors

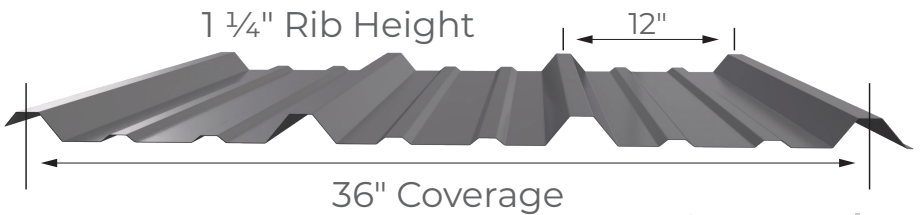

2 Week
lead time

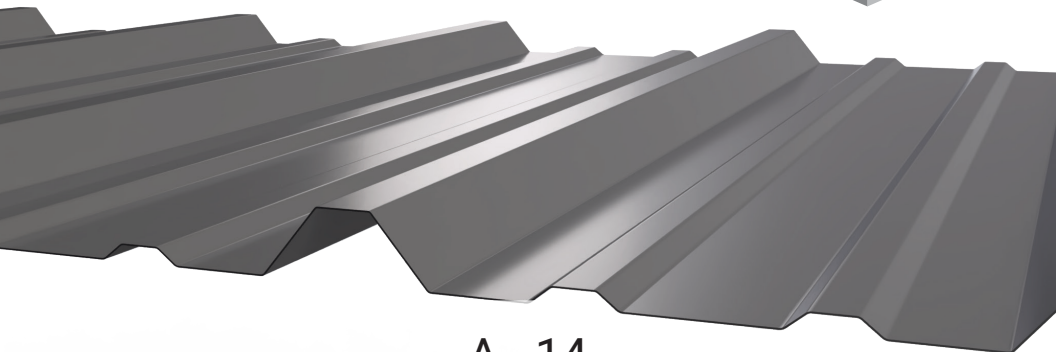

A - 14



All trims are available in 10'6", 12'6", 14'6", 16'6", 18'6" and 20'6"

Ridge

RP RC RP 20" Ridge Cap

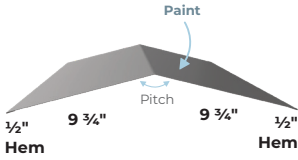

RPFR36 PBR 36" Formed Ridge Cap

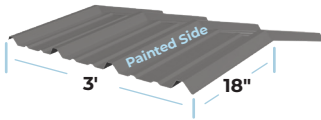

RPSHS RP Sculptured High Side

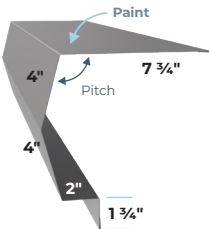

Corner

RPC RP 6" Corner

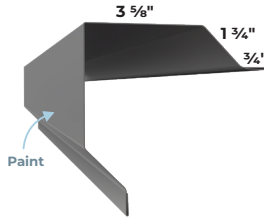

RPBR RP Box Rake

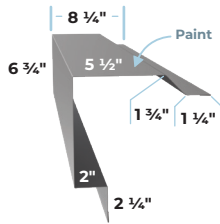

RPC RP 6" Inside Corner

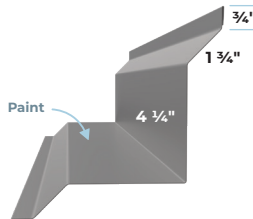

Valley

RPVA20 RP 20" Valley

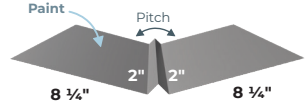

RPVA40 RP 40" Valley

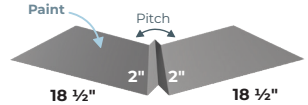

RPSR RP Sculptured Rake

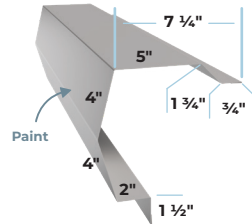



All trims are available in 10'6", 12'6", 14'6", 16'6", 18'6" and 20'6"

Misc.

RPJ RP J-Channel

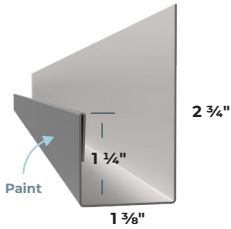

RPFJ1 RP 1-3/8" F&J

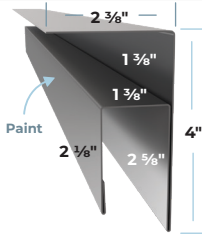

RPODJ RP Overhead Door Jamb

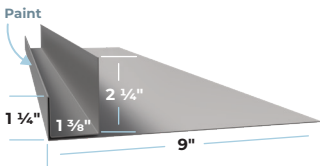

RPJT RP Jamb Trim

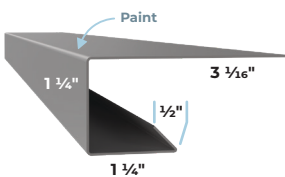

Base

RPRG RP Rat Guard

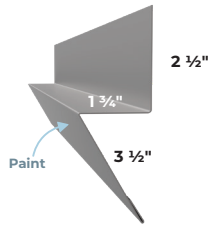

RPBA RP Base Angle

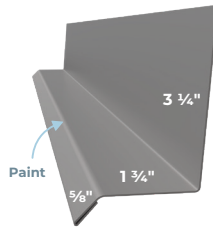

Transition

RPSW RP Sidewall

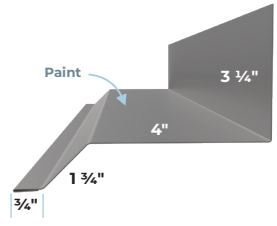

RPEW RP Endwall

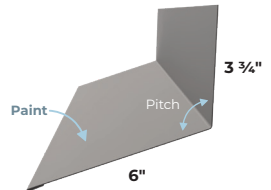

RPTI RP Tie In Trim

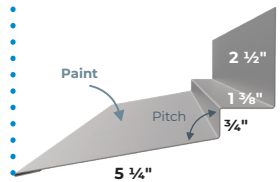

RPHSP RP High Side Parapet

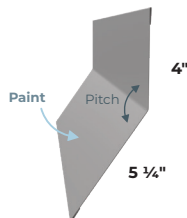

RPLG RP Lower Gambrel

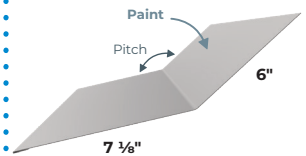



All trims are available in 10'6", 12'6", 14'6", 16'6", 18'6" and 20'6"

Gutter Trim and Accessories

RPSHO RP Sculptured Hang-On

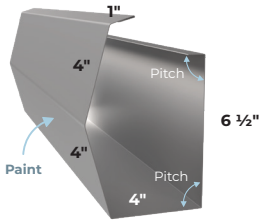

RPGGS RP Flat Gutter Strap

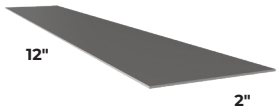

RPSCE RP Sculptured Eave

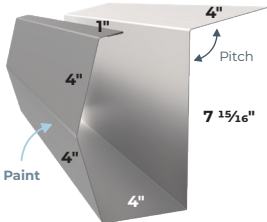

RPGS RP Gutter Strap

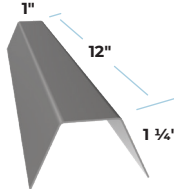

RPBHO RP Box Hang-On

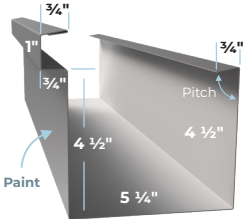

RPDS RP Downspout

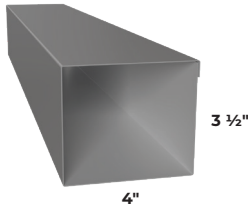

RPBE RP Box Eave

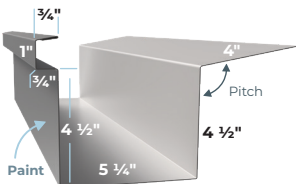

Eave

RPLE RP Long Eave

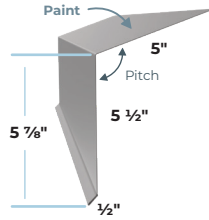

Wainscot

RPWT RP Wainscot Trim

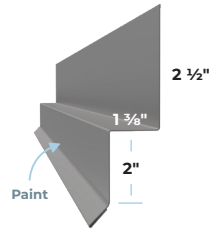

RPDA RP Double Angle

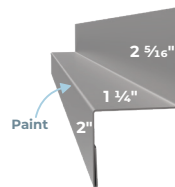



Metal to Wood Screw



Product Features:

- 1/4" Hex Head
- Hi-Low Threads
- Mechanical Zinc
- Type 17 Point
- EPDM Bonded washer - eliminates bulging, creating an excellent seal

MW**34	#12 3/4" STITCH Wood Screw	250/Bag	3,000/Box
MW**1	#10 1" Wood Screw	250/Bag	3,000/Box
MW**112	#10 1-1/2" Wood Screw	250/Bag	2,500/Box
MW**2	#10 2" Wood Screw	250/Bag	2,000/Box
MW**212	#10 2-1/2" Wood Screw	250/Bag	1,500/Box
MW**3	#10 3" Wood Screw	250/Bag	1,000/Box

Metal to Metal Screw



Product Features:

- 5/16" Hex Head
- Self Drilling
- EPDM Bonded washer - eliminates bulging, creating an excellent seal

MM**78	#14 7/8" LAP Metal Screw	250/Bag	2,500/Box
MM**114	#12 1-1/4" Metal Screw	250/Bag	2,500/Box

Stainless Steel Cap Screw



#10

MWSSCBW1	1" SS Cap Wood Screw Brilliant White	250/Bag	3,000/Box
MWSSCBW112	1-1/2" SS Cap Wood Screw Brilliant White	250/Bag	2,500/Box

Product Features:

- 1/4" Hex Head
- Hi-Low threads
- Stainless Steel cap - no rust

In stock in Brilliant White ONLY

PVC One Stepper Screw



#12

PVCWBW114	1-1/4" One Stepper 304 Soft Stainless Steel Screw	500/Bag	2,500/Box
------------------	---------------------------------------------------	---------	-----------

Product Features:

- 1/4" Hex Head
- Self-drilled expansion hole prevents cracking

In stock in Brilliant White ONLY



OSB/Replacement Screw



#12

MWNRBW1	1" Brilliant White	250/Bag	2,500/Box
MWNRBW112	1-1/2" Brilliant White	250/Bag	2,000/Box
MWNRBW2	2" Brilliant White	250/Bag	1,500/Box
MWNRBW212	2-1/2" Brilliant White	250/Bag	1,500/Box

Product Features:

- 1/4" Hex Head
- Great for replacing nails
- Engineered for OSB application

In stock in Brilliant White

Shadow Grip Screw

#12



MWSG1	1" Shadow Grip Bare	250/Bag	2,500/Box
--------------	---------------------	---------	-----------

Product Features:

- 1/4" Hex Head
- Thicker #12 Shank
- Type 17 Point
- High - Low Thread



1 screw per linear foot of Metal Batten panel plus fasteners for trim

Recommended for Metal Batten

Skylight Screw

#14



MWSKBW112	1-1/2" Brilliant White	100/Bag	1,000/Box
------------------	------------------------	---------	-----------

Product Features:

- 3/8" Hex Head
- Skylight to wood fastener

In stock in Brilliant White ONLY

Low Profile Screw

T-25



MWLPBW1	1" Brilliant White	250/Bag	3,000/Box
MWLPBW112	1-1/2" Brilliant White	250/Bag	2,500/Box

Product Features:

- T-25 Head
- Low profile for finished look

In stock in Brilliant White ONLY



Metal to Wood Pancake Screw



MWPCT1 1" T-25 Torx Head Pancake Screw 250/Bag 3,000/Box

T-25 Torx Head

1 screw per linear foot of
Snap Lock panels plus
fasteners for trim

3/16" Rivet



RI316** 3/16" Rivet 250/Bag

Figure 1 rivet every 2 ft. for
Z-Closure and Snap Vent

Trim Nails



NA114** 1-1/4" Stainless Steel Trim Nail 1LB. Box

Trim nails work great when you have a detailed application like post wraps, header covers, or even fascia boards. You may want this clean appearance on your next project!



Product Features:

- Stainless steel
- 1-1/4" ring shank
- Great for detailed trim applications

Standard



IN STOCK

Best Seller



Withstands up to 238° F

PF1	#1	1/4" - 2-1/2"	10/Box
PF2	#2	1-3/4" - 3-1/4"	10/Box
PF3	#3	1/4" - 5"	10/Box
PF4	#4	3" - 6-1/4"	10/Box
PF5	#5	4-1/4" - 7-1/2"	5/Box
PF6	#6	5" - 9"	5/Box
PF7	#7	6" - 11"	5/Box
PF8	#8	7" - 13"	5/Box
PF9	#9	10" - 19"	5/Box

Colored



IN STOCK

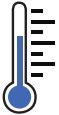

Withstands up to 238° F

PF3	#3	1/4" - 5"	15/Box
PF5	#5	4-1/4" - 7-1/2"	10/Box
PF*BW	Brilliant White		
PF*DB	Dark Blue		
PF*DG	Dark Green		
PF*LB	Light Blue		
PF*LG	Light Green		
PF*TC	Terra Cotta		
PF*BN	Brown		
PF*BR	Bright Red		



Square



IN STOCK



Withstands up to 238° F

PF2S	#2	1/4" - 3"	20/Box
PF3S	#3	1/4" - 4"	20/Box
PF4S	#4	3" - 6"	10/Box
PF5S	#5	4" - 7"	10/Box
PF6S	#6	5" - 9"	10/Box
PF7S	#7	6" - 11"	10/Box
PF8S	#8	7" - 13"	5/Box
PF9S	#9	10" - 18"	5/Box

DEKS

B - 4

Hi-Temp Gray



Withstands up to 392° F



Hi-Temp



PFH3 #3 1/4" - 5" 10/Box

PFH4 #4 3" - 6-1/4" 10/Box

PFH5 #5 4-1/4" - 7-1/2" 5/Box

PFH6 #6 5" - 9" 5/Box

PFH7 #7 6" - 11" 5/Box

PFH8 #8 7" - 13" 5/Box

PFH9 #9 10" - 19" 5/Box



Hi-Temp Red



Withstands up to 392° F



PFH3R #3 1/4" - 5" 10/Box

PFH4R #4 3" - 6-1/4" 10/Box

PFH5R #5 4-1/4" - 7-1/2" 5/Box

PFH6R #6 5" - 9" 5/Box

PFH7R #7 6" - 11" 5/Box

PFH8R #8 7" - 13" 5/Box

PFH9R #9 10" - 19" 5/Box



Square Hi-Temp



Withstands up to 392° F



PFH3S #3 1/4" - 5" 20/Box

PFH4S #4 3" - 6-1/4" 10/Box

PFH5S #5 4-1/4" - 7-1/2" 10/Box

PFH6S #6 5" - 9" 10/Box

PFH7S #7 6" - 11" 10/Box

PFH8S #8 7" - 13" 5/Box

PFH9S #9 10" - 18" 5/Box



RetroFit™

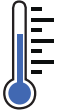

Withstands up to 238° F



PFR1 #1 3/4" - 2-3/4" 10/Box

PFR2 #2 2" - 7-1/4" 5/Box

PFR3 #3 3-1/4" - 10" 5/Box



Combo Black

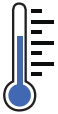

Withstands up to 238° F



PFC3B #3 1/4" - 5" Black 15/Box

PFC4B #4 3" - 7" Black 10/Box

PFC5B #5 4-1/4" - 7-1/2" Black 10/Box

Combo



Withstands up to 238° F



PFC3 #3 1/4" - 5" 15/Box

PFC4 #4 3" - 7" 10/Box

Extreme Angle

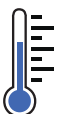

Withstands up to 238° F



PFEA3 #3 1/4" - 6-1/4" 5/Box

Product Features:

- Fits a 10/12 roof pitch
- For a pipe 4" or less the roof pitch range is 8/12 - 12/12

3/4" Rib Skylight Panel

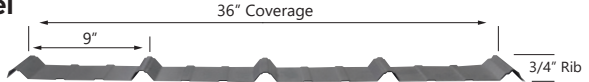

SK9CL12 12' Clear 300/Pallet

Product Features:

- Has a 9" on-center profile
- Has a 10 Year warranty
- Withstands extreme climates (-40°F - 212°F)
- Is hail and wind resistant
- Will not yellow
- Has 100% UV protection
- Retains excellent optical clarity

Well suited for a broad range of agricultural, commercial, and industrial applications including:

- Warehouses
- Dairy, hog, poultry and cattle barns
- Agricultural pole barns
- Nearly any other application

Skylight Ridge Cap



SKRCCL 10' 6" Ridge Cap Clear 200/Pallet

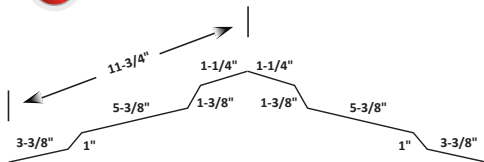

Product Features:

- Has a 10 Year warranty
- Withstands extreme climates (-40°F - 212°F)
- Retains excellent optical clarity
- Is hail and wind resistant
- Will not yellow
- Has 100% UV protection



CCBA12 Classic Corrugated 29 BARE GALVALUME

25/Box 100/Pallet

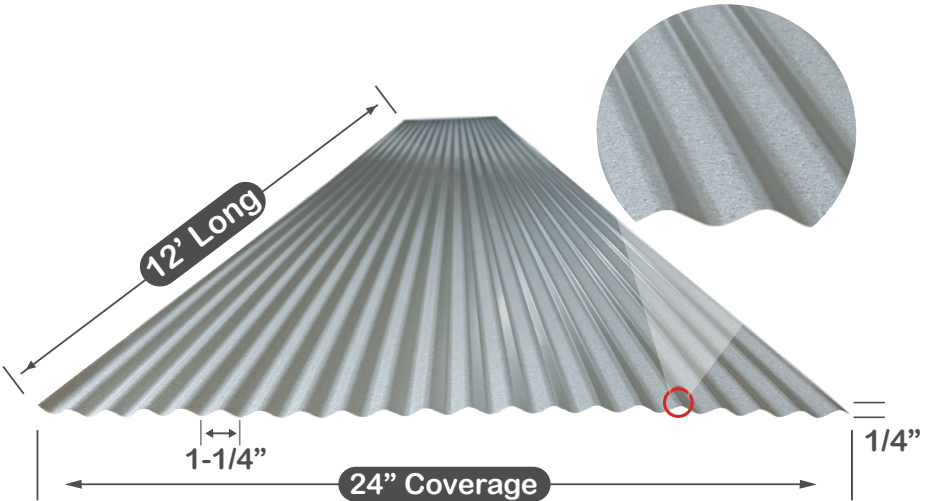

Only available in Bare Galvalume

Only available in 12' length

Available in **TEXTURED**

3-1/2" Ridge Ventilator



VERV35BW 3-1/2" Ridge Ventilator BRILLIANT WHITE In stock

VERV35 3-1/2" Ridge Ventilator Confirm lead time when ordering

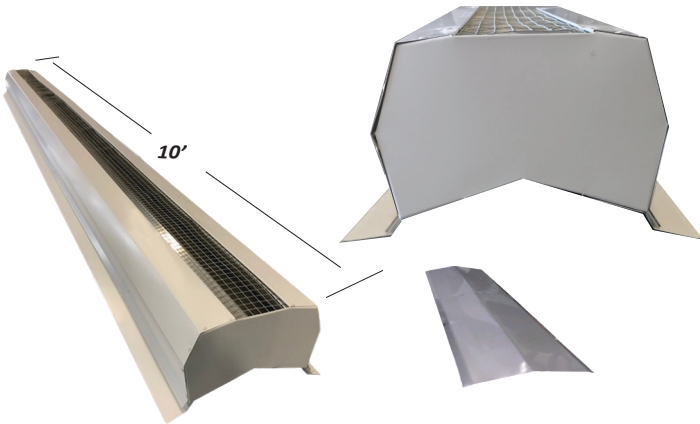

Approximately 36 Sq. In. of free area per linear foot

Ridge Cap profile for this vent

Why a Stainless Steel diverter?

12" Ridge Cap (RC)

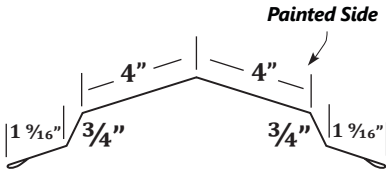

- In our studies the diverter is the first thing to deteriorate, leaving your investment unprotected.
- Our stainless steel diverter outlasts any steel or fiberglass diverter on the market.



Available as a lighted cupola!



CULI	LED Light Kit W/Photo Cell	
CUT	TEXTURED Metal Cupola	
CU18	18" x 18" Cupola w/Base	1/Box
CU24	24" x 24" Cupola w/Base	1/Box
CU36	36" x 36" Cupola w/Base	1/Box
CU48	48" x 48" Cupola w/Base	1/Box

**Confirm lead times
when ordering!**



Double Check

Please specify the roof pitch and choose your colors for the roof, sides, corners, and base of your cupola when placing an order.

- **Arrives fully assembled in a crate**
- **Is very detailed and extremely heavy-duty**
- **Has a built-in mesh screen to keep birds out**

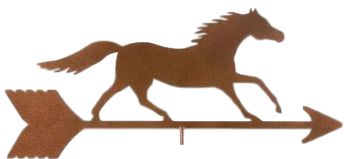

WEHO 21" Weathervane Horse

WEBF 21" Weathervane Bass Fish

WEBU 21" Weathervane Buck

WEDU 21" Weathervane Duck

WERO 21" Weathervane Rooster

WETR 21" Weathervane Tractor

WEAA 21" Weathervane Antique Auto

WECC 21" Weathervane Cow With Calf



Confirm lead times when ordering!

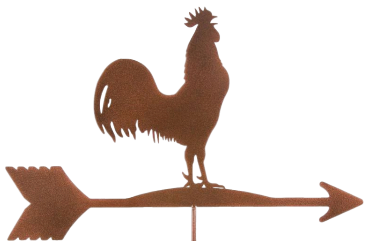

Snow Guard

SGP Snow Guard Polycarbonate CLEAR 50/Box



Product Features:

- Polycarbonate material for optimal strength
- Reinforced struts for additional holding power
- 1.5" Base will fit 95% of roof panels
- UV Resistant

Snow Guard has a transparent face so you can see the roof color easily.

Keep a box in your job trailer for above sidewalks, walk-in doors, and overhead doors.

Bending Bar - Hemmer



SLTOOL Bending Bar - Hemmer



For Snap Lock Drip Edge
and Offset Cleat

Touch Up Pen



TUP** Touch Up Pen 24/Box



Touch up paint pens are a great way to fix up minor scratches that may have happened during shipping or installation. Keep some on hand to be prepared!

Seal Foam

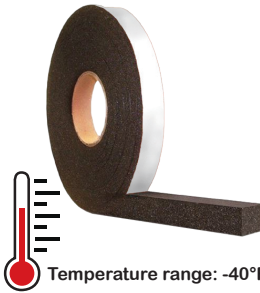

Temperature range: -40°F to 185°F



SEEM1 1" x 1" x 19.68' Roll 26/Box

SEEM112 1-1/2" x 1" x 13.12' Roll 24/Box

Product Features:

- Supplied with self adhesive on one side. After removal of packaging, material begins gradual expansion - more slowly in cold weather than in hot
- Will not dry out and become hard and brittle
- Is UV-stable
- Conforms to contours and fills gaps
- Is highly resistant to bugs and vermin
- Will not extrude from between joints like caulk or butyl tapes
- Maintains seal during thermal expansion and contraction of building panels

Butyl Tape



Installation Diagram



SEBU1 1" x 3/32" x 50' Roll 10/Box

SEBU3 3/8" x 3/32" x 45' Roll 48/Box

Product Features:

- Has superior adhesive strength
- Is resistant to UV light
- Withstands extreme roof temperatures
- Seal is not affected by expansion and contraction of metal

Caulk



SECA Metal Roof Sealant 10.1 oz. 12/Box

Metal Roof Sealant provides a weather tight seal against water, wind, dust, and dirt. It offers exceptional adhesion to standard metal, aluminum, steel, galvanized surfaces, plastics, and glass. It also provides unbeatable adhesion to wood, masonry, PVC, and most common building materials.

Product Features:

- Remains perfectly flexible
- May be painted with water based paints 1 hour after application
- Is suitable for all climates
- Produces long-lasting weather-tight seals

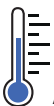

Application Temp: above 0° F



Foam Closures



FCO	3/4" Rib OUTSIDE Closure w/adhesive	100/Box
FCl	3/4" Rib INSIDE Closure w/adhesive	100/Box
FCOR	PBR OUTSIDE Closure w/adhesive	100/Box
FCIR	PBR INSIDE Closure	100/Box



3/4" Rib Outside Closure



3/4" Rib Inside Closure



PBR Outside Closure



PBR Inside Closure

Product Features:

- Dimensions: 36" x 1"
- High-density, blocks air flow
- Exceptional adhesion to building materials
- UV light resistant

LP2 Vent Strip



VELP	3' LP2 Ridge Vent Strip	25/Box
-------------	-------------------------	--------



Product Features:

- Pre-applied adhesive
- High airflow for good ventilation
- 3/4" rib profile for a tight seal against the weather
- Tough mesh does not wrap up on screws

Uni-Vent



VEU	1" x 1-1/2" x 20' Uni-Vent Roll	135/Box
------------	---------------------------------	---------



Product Features:

- Has a pre-applied adhesive
- Ventilates under ridge cap and hips
- Figure 1 Roll per 10' 6" Ridge Cap

Understanding Our Substrates

G100 Galvanized Substrate

Hot dipped zinc coating

Measured in weights of G60, G90, and G100

G100 means 1 oz of zinc per sq. ft. top and bottom combined

Suggested Uses



- Hog barns

PRIME 3/4" Rib Galvalume Substrate

- 55% Aluminum, 45% Galvanized by volume
- Application is measured by oz./sq. ft. on both sides
- AZ50 coating is used for PRIME
- AZ35 is used for liner panel

Suggested Uses



- Commercial



- Residential



- Polebarns

THICKNESS of Substrate Coatings

The heavier the substrate coating, the more years of protection you will enjoy.

Note: G90 will last 50% longer than G60.

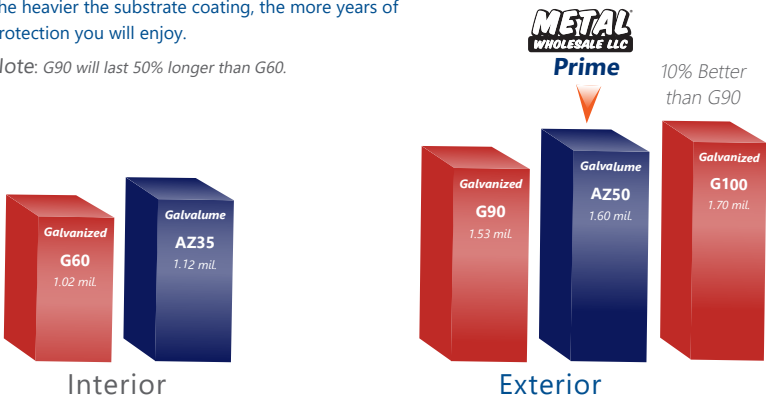

Interior

Recommended for interior liner panels because of the minimal protection against corrosion.

Exterior

Recommended for exterior. The heavier coatings will offer superior protection against corrosion.

Layers of Protection

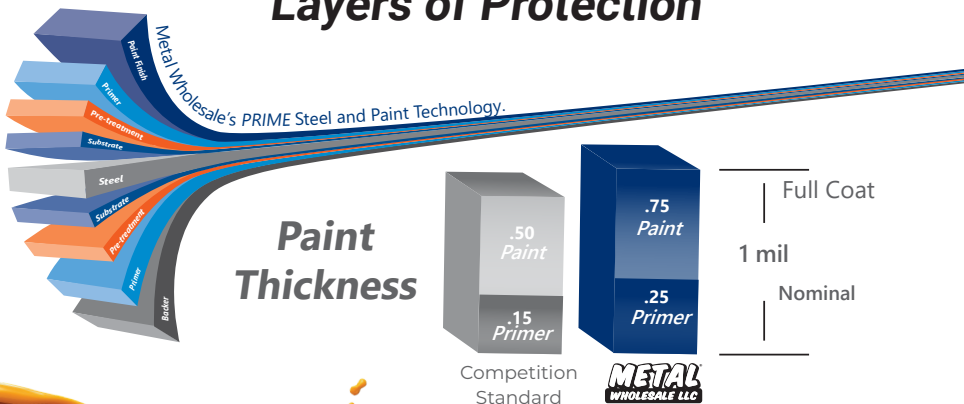

Paint Types

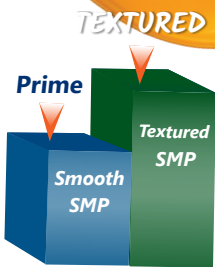

Textured - (SMP) - The absolute top in color retention which results in maximum protection against fading.

Smooth - (SMP) Most widely used on building products with standard protection against fading and chalking.

Steel Thickness

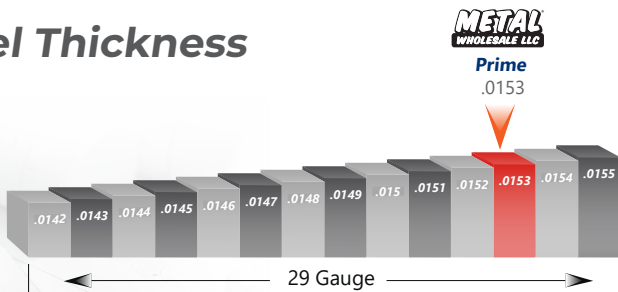



TEXTURED Wins Again!

The Metal Wholesale Team is doing research at a paint testing fence in southern Florida. We are very diligent about quality products and have product samples from our production facility on the test fence in every color we offer. Our Research Team has partnered with the top coating companies in the industry to test TEXTURED metal coatings and reach the same results every time. TEXTURED metal coatings will outperform Smooth SMP when it comes to fading and color retention.

Original
(Not Exposed)

10 Year Acceleration
(Exposed on test fence)



TEXTURED



Smooth SMP
(Silicone Modified Polyester)

These samples have been exposed to the harsh conditions of southern Florida for over 5 years. These intense conditions, equivalent to more than twice the exposure of anywhere north of Jacksonville Florida, rapidly accelerates the fading on painted panels and is the reason a lot of metal roofs in southern Florida are unpaired.





Textured Metal Advantages

- Exceptional color retention
- Extra fade resistant
- Extremely durable finish
- Non-slip footing for safety
- Elegant style with a matte finish
- All your friends will love it!



The unique texture of Metal Wholersale's TEXTURED finish redirects light for enhanced visual depth, promising an improvement over the regular smooth finish. The responsive design allows its subtle shading to mirror the eye's motion, creating beautiful, shifting, shimmering tones.

Testimonials

- What I like about TEXTURED metal roofing, as a contractor and installer, is that it hides a lot of small wrinkles or scratches that can happen during installation and it also brings out your color nicely. It doesn't have that glare from the sun. I would use TEXTURED paint over smooth on any job! - Norman Gingerich
- The appearance and durability of TEXTURED products adds value to almost any project. - KC Builders
- TEXTURED metal gives your home a softer appeal, not shiny and glistening like the smooth pole barn metal. It's easier to walk on during installation, especially on steeper slopes, and in adverse conditions. - John Wagler

Info Section

Roof Metal Length Calculation

Roof Pitch	Slope Factor
12/12	1.414
10/12	1.302
8/12	1.202
6/12	1.120
5/12	1.083
4/12	1.054
3/12	1.031
2/12	1.014
1/12	1.0035

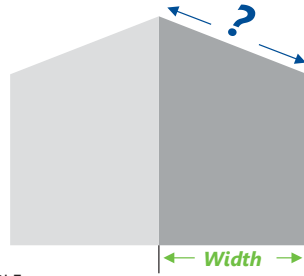

EXAMPLE

1.054 (4/12 pitch) x 20' Width = 21' Roof Panel Length



Remember to include overhangs in the width

**Slope
Factor**

x

Width

=

Roof Panel Length

How to Figure Screw Quantity

PRIME 3/4" Rib Panel

100 Linear feet = 1 Bag



Snaplock Panel

Metal Batten Panel

250 Linear feet = 1 Bag



PBR Panel

150 Linear feet = 1 Bag



C - 19

Square Conversions

Industry Standard

Figuring 38" wide

PRIME 3/4" Rib Panel



PBR Panel

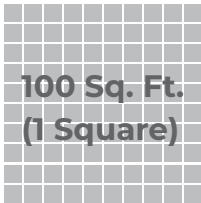

100 Sq. Ft.
(1 Square)



31.58 LF of Panel

Actual Coverage

Figuring 36" wide equals 33.33 LF of Panel

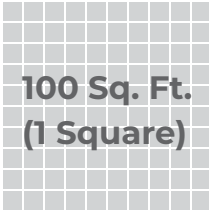

100 Sq. Ft.
(1 Square)



16" Snaplock Panel

75 LF of Panel

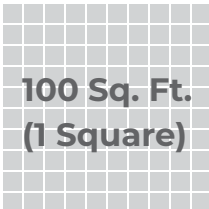

100 Sq. Ft.
(1 Square)



Metal Batten Panel

120 LF of Panel

Info Section

Trims Placement Chart

All trims are available in 10'6", 12'6", 14'6", 16'6", 18'6" and 20'6"

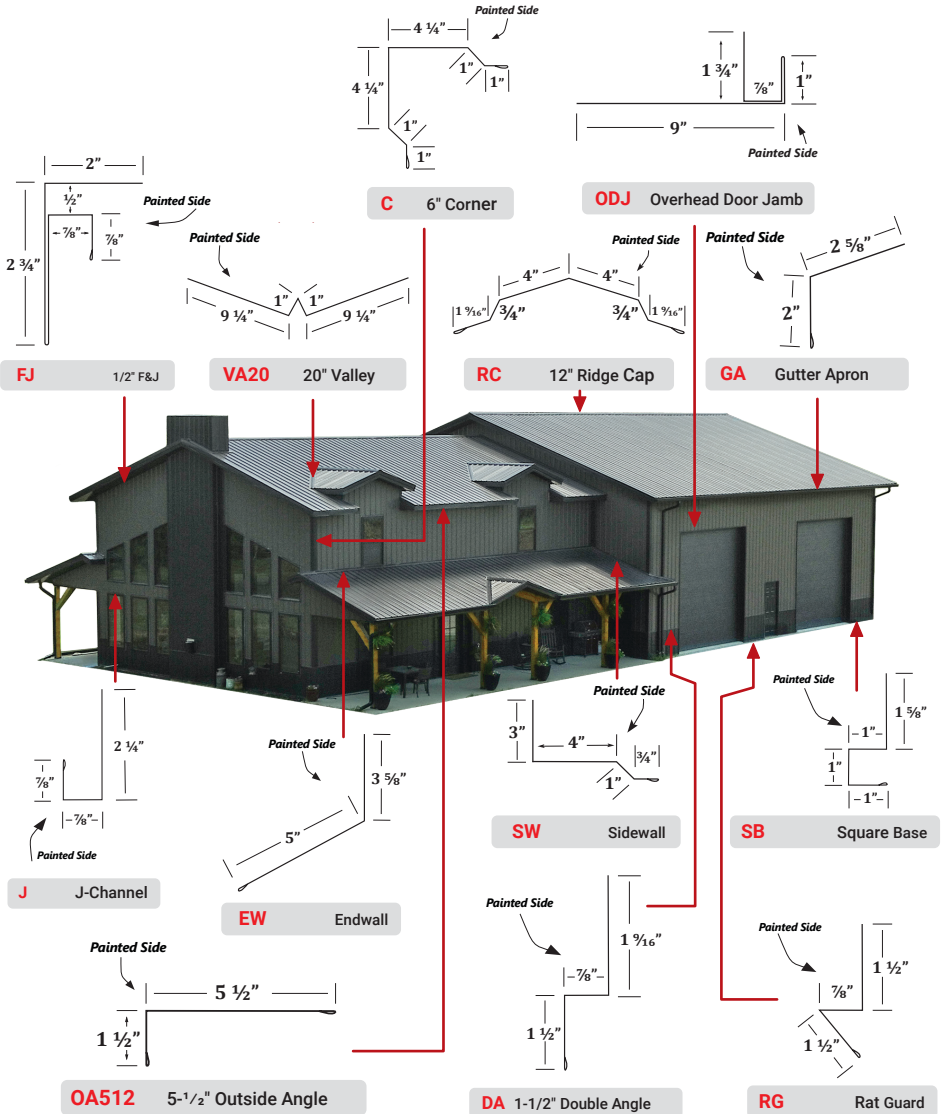

Color Availability Chart

Info Section



	Page A11	Page A12	Page A1		Page A14	Page A8
	SPEEDLAP	Metal Batten	PRIME 3/4" Rib		PBR	Snaplock
	29 Gauge	29 Gauge	29 Gauge	26 Gauge	26 Gauge	26 Gauge
STANDARD LEAD TIMES	1 Week	2 Weeks	2-5 Days	2 Weeks	2 Weeks	2 Weeks
AL Alamo White	●	●	●	●	●	●
AG Ash Gray	●	●	●	●	●	●
BA Bare Galvalume	●	●	●	●	●	●
BW Brilliant White	●	●	●	●	●	●
BR Brite Red	●	●	●	●	●	●
BN Brown	●	●	●	●	●	●
BU Buckskin	●	●	●			
BG Burgundy	●	●	●	●	●	●
BS Burnished Slate	●	●	●	●	●	●
CH Charcoal	●	●	●	●	●	●
CM Copper Metallic	●	●	●			●
DG Dark Green	●	●	●	●	●	●
GB Gallery Blue	●	●	●	●	●	●
HU Hunter Green	●	●	●	●	●	●
IV Ivory	●	●	●			
LS Light Stone	●	●	●	●	●	●
MB Matte Black	●	●	●	●	●	●
OC Ocean	●	●	●			●
PG Pewter Gray	●	●	●	●	●	●
RU Rustic Red	●	●	●	●	●	●
TN Tan	●	●	●	●	●	●
TA Taupe	●	●	●	●	●	●
WO Warm Oak	●	●	●			
WG Weathered Gray	●	●	●			
TAG Textured Ash Gray	●	●	●			
TBW Textured Brilliant White	●	●	●			
TBN Textured Brown	●	●	●			
TBG Textured Burgundy	●	●	●			
TBS Textured Burnished Slate	●	●	●			●
TCH Textured Charcoal	●	●	●			●
TDG Textured Dark Green	●	●	●			
TGB Textured Gallery Blue	●	●	●			
TGR Textured Graphite	●	●	●			●
TMB Textured Matte Black	●	●	●			●
TRU Textured Rustic Red	●	●	●			
TTA Textured Taupe	●	●	●			



Snap Lock Panel - 16"



Metal Batten Panel - 10"



SPEEDLAP Soffit Panel - 16"

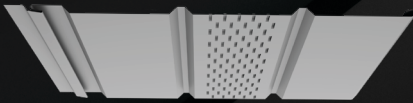

PBR Panel - 36"



3/4" Rib Prime Panel - 36"

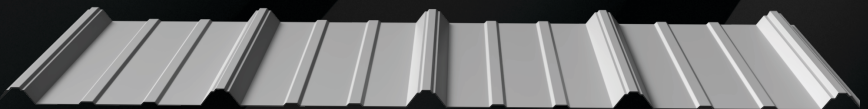

888-509-4819

Sales@MetalWholesaleLLC.com



MetalWholesaleLLC.com

2025